

USER AND MAINTENANCE MANUAL

Ø 45 mm and Ø55 mm tubular motors with electronic limit switch and radio receiver



Dear Customer, thank you for purchasing a STAFER product. This manual describes the operations necessary for the correct installation of the V6RX.E3 / V7RX.E3 products. These tubular motors with electronic limit switches are suitable for handling the most popular types of rolling shutters. The motor's technical specifications are shown on the label affixed to the motor tube. These devices have not been designed for round-the-clock use. Any use of the product other than what is provided herein is improper and prohibited, and involves warranty voidance and liability disclaimer by the Manufacturer. The product must be assembled and installed only by a qualified technician. At the end of installation, all the manuals accompanying the product must be delivered to the end customer, who must keep them for future reference. Visit the site www.stafer.com to view updated documents, if any.

Index

01. Technical specifications of motors and remote controls
02. Warnings
03. Rating tables and motor components
04. Electrical connection
05. Some information on motor operation
06. Movement control functions
07. Installation via command buttons
08. Installation via remote control
09. Add/delete a radio device
10. Upper limit switch fine-tuning
11. Lower limit switch fine-tuning
12. Button logic
13. Third limit switch (preferred position)
14. Third limit switch inversion
15. Sun/wind anemometer
16. Radio test for anemometer
17. Shutter release
18. Orientation (micro movements)
19. Reset to factory values

Compatible STAFER remote controls



www.stafer.com

Let's protect the environment

Protecting the environment is everyone's duty! STAFER uses recyclable packaging materials. Dispose of materials in proper containers, in compliance with laws in force in your location. If you are an installer and use a large number of motors, ask your dealer or the Company about receiving motors in "honeycomb pads", an environmentally friendly choice that limits clutter and waste by significantly reducing the amount of packaging materials. This product may contain substances that are polluting for the environment and dangerous to health. At the end of the product life cycle, carefully comply with the appropriate waste disposal rules. It is hazardous, and thus strictly forbidden to dispose of the product in the domestic waste.

Notes on radio systems

It is advisable to avoid using radio systems in areas with strong interference (for example, near police stations, airports, ports, banks, etc.). A technical inspection is in any case advisable before installing any radio system in order to identify sources of interference. Radio systems can be used where possible disturbances or malfunctioning of the transmitter or the receiver do not cause a risk factor, or if the risk factor is cancelled by suitable safety systems. The presence of radio devices operating on the same transmission frequency (433.42 MHz) can interfere with the radio receiver of the device and thus reduce the range of the system and limit the functionality of the entire system.

01. TECHNICAL SPECIFICATIONS

The motor's technical features are shown on the label affixed to the motor tube. Before installing the motor, we recommend that you copy the technical data (including the full product name) and store them in a safe place. These data could be useful at the time of maintenance or technical assistance. Additional features common to the V6RX.E3/V7RX.E3 motor family.

| | | | | | |
|--------------------------------|-----------------|----------------------------------|-------------|----------------------------------|--------------|
| Power supply | : 230 Vac 50 Hz | Protection grade | : IP44 | Radio frequency | : 433.42 MHz |
| Idle consumption | : < 0,5W | Insulation class | : H | Storable portable transmitters | : 40 |
| Minimum V6RX.E roller diameter | : 50 x 1.5 mm | Maximum limit switch revolutions | : ∞ | Storable sun/wind radio sensors: | : 1 |
| Minimum V7RXE roller diameter | : 60 x 1.5 mm | Revolving operating time | : 4 minutes | | |

01.1 Remote control "function" buttons

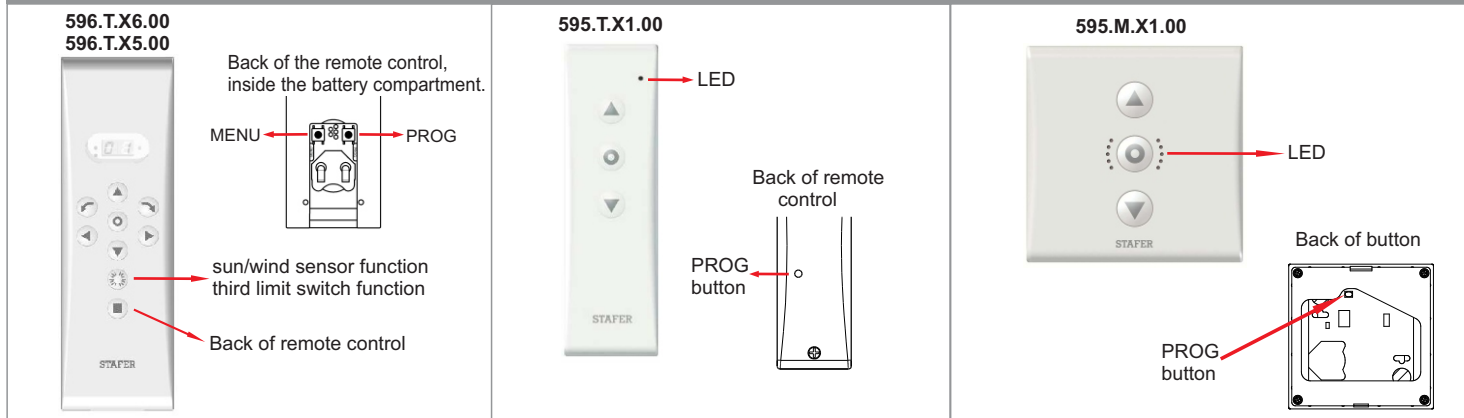

02. WARNINGS

02.1 Safety warnings

Incorrect installation can cause serious injuries. • Keep these instructions for future maintenance operations and the disposal of the product. • All the product installation, connection, programming and maintenance operations must be carried out only by a qualified and skilled technician, who must comply with laws, provisions and local regulations, and the instructions provided herein. • Wiring must comply with current CEI standards. In compliance with the provisions of Italian Ministerial Decree 37/2008, the final electrical system must be installed only by an electrician. • Some applications require "man present" operation and can exclude the use of radio commands or require particular safety devices. • To prevent potentially dangerous situations, regularly check the operating condition of the rolling shutter/awning.

02.2 Installation warnings

Check that the package is intact and has not been damaged during transport. • A heavy shock and the use of unsuitable tools can cause the damage of the external or internal parts of the motor. • Do not pierce or tamper with the motor in any way. Do not modify or replace parts without the Manufacturer's permission. • Do not handle the motor by the power cable. If the power cable is damaged, the product cannot be used. Do not attempt to replace the power cable. • Make sure that screws required to complete the installation do not come into contact with the motor. • The motor must be of power adequate to the charge (check the rating plate data on the motor). • Some programming phases and/or normal operation leverage the mechanical stops of the rolling shutter. It is essential to select the motor with the torque deemed most suitable for the application, considering the actual traction of the rolling shutter; therefore, we recommend avoiding very powerful motors. • Use coils with a minimum thickness of 10/10. • Leave 1-2 mm clearance on right/left on the coiler. • Check that the drive pulley and the adapter crown are of shape and dimensions appropriate for the coiler used. Motor accessories, adapters and supports must be selected exclusively from the STAFER catalogue. • If the product is installed at a height of less than 2.5 m from the floor or other supporting surface, it is necessary to protect the moving parts with a cover, in order to prevent accidental access. In any case, guarantee access for maintenance operations. • The power cable must be positioned in such a way as to avoid contact with moving parts. • The product power cable is suitable for indoor installation only. If installing outdoors, lay the cable in a protective tube. • If there are several radio appliances in the same system, make sure they are at least 1.5m apart. • Do not install the product near metal surfaces. • Position the buttons in view of the rolling shutter, but away from its moving parts. Place the buttons at a height greater than 1.5 m from the floor. • The motors are designed for residential use; they are designed for a continuous maximum work time of 4 minutes. • During operation, the motor body reaches high temperatures: use caution. • The motor is internally fitted with a self-restoring thermal safety device, which stops the motor in the event of overheating. The motor returns to normal operation when its temperature drops below the safety limit (normally from 5 to 10 minutes). • The motor must be installed in such a way that it does not come into contact with liquids and, in any case, in a location protected from the elements. • The antenna cable is subjected to mains voltage. It is forbidden and dangerous to tamper with the antenna cable. Replace the product if the antenna cable is damaged. • For your safety, do not work near the coiler while the motor is powered.

02.3 Use warnings

The product is not intended to be used by persons (including children) with reduced physical, sensory or mental capabilities, or lack of experience and knowledge, unless they are supervised or given instructions about the product way of use by a person responsible for their safety. • Before operating the rolling shutter, make sure that people or things are not in the area affected by the movement of the rolling shutter. Check the automation during operation and keep people at a safe distance until the end of operation. • Do not allow children to play with the appliance or with control devices. • Do not operate the rolling shutter when maintenance operations are being carried out (e.g. window cleaning, etc.). If the control device is automatic, disconnect the motor from the power line.



03. RATING TABLES AND MOTOR COMPONENTS

| V6RX.E3 | Model | Torque (Nm) | Rpm | Consumption (W) | Model | Torque (Nm) | Rpm | Consumption (W) |
|---------|---------------|-------------|-----|-----------------|---------------|-------------|-----|-----------------|
| | V6RX.E3 15/13 | 15 | 13 | 125 | V6RX.E3 8/17 | 8 | 17 | 105 |
| | V6RX.E3 27/13 | 27 | 13 | 190 | V6RX.E3 12/17 | 12 | 17 | 125 |
| | V6RX.E3 35/13 | 35 | 13 | 230 | V6RX.E3 22/17 | 22 | 17 | 190 |
| | V6RX.E3 45/13 | 45 | 13 | 290 | V6RX.E3 28/17 | 28 | 17 | 230 |
| | | | | | V6RX.E3 38/17 | 38 | 17 | 290 |

A=power cable / B=base crown / C=insertion key / D=adapter crown / E=output pinion / F=drive pulley / G=coupling tooth / H=coupling clips (to remove the pulley, widen the clips and pull lightly) / I=gearmotor body / J=nameplate data

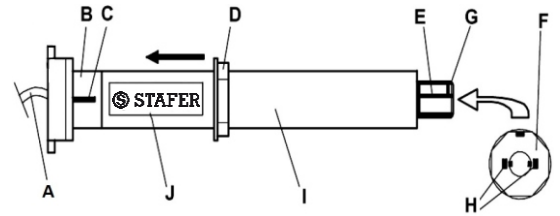

| V7RX.E3 | Model | Torque (Nm) | Rpm | Consumption (W) |
|---------|----------------|-------------|-----|-----------------|
| | V7RX.E3 80/12 | 80 | 12 | 375 |
| | V7RX.E3 100/12 | 100 | 12 | 410 |
| | V7RX.E3 130/9 | 130 | 9 | 410 |

A=power cable / B=base crown / C=insertion key / D=adapter crown / E=output pinion / F=drive pulley / G=washer / H=locking screw / I=gearmotor body / J=nameplate data

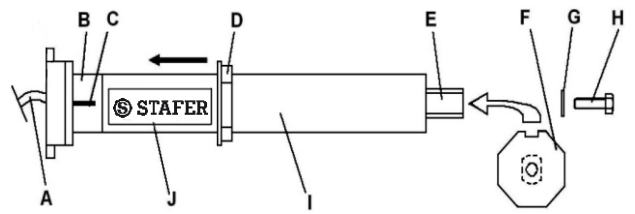

04. ELECTRICAL CONNECTION

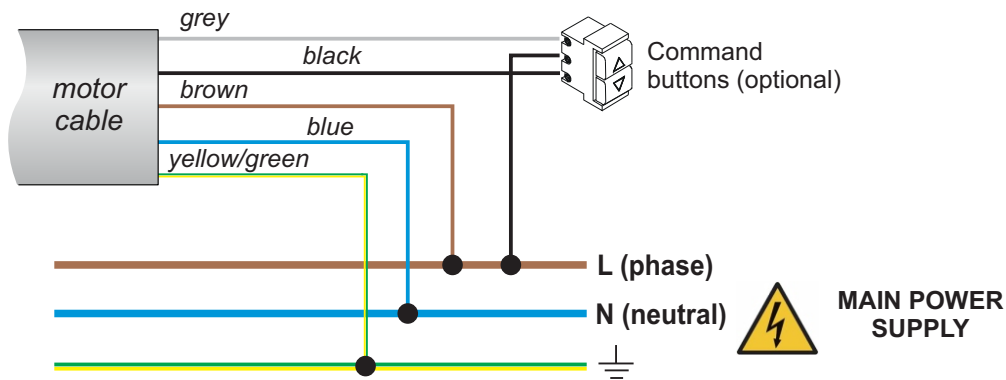

04.1 Warnings for the electrician

Make all connections with the power supply disconnected. • Check that the power line does not feed on electrical circuits to be used for lighting. • The power line must be equipped with a magneto thermal or differential circuit breaker. A category III over voltage disconnection device must be fitted on the power supply line, i.e. at a distance of at least 3.5 mm between the contacts. • The section of the connecting cables must be proportionate to their length and to the power load absorption, and, in any case, not less than 1.5 mm. • The product does not provide for any protection against overloads or short circuits. Provide adequate protection for the load on the power supply line, for example a fuse with a maximum value of 3.15 A. • Command buttons are connected to the main voltage, so they must be properly insulated and protected.

04.2 Power supply

The supply voltage must be applied to the BROWN (phase) and BLUE (neutral) wires. Always connect the YELLOW-GREEN wire to the earthing system. The motor's technical specifications are shown on the label affixed to the motor tube.

04.3 Command buttons

The command buttons are optional. If used, the command buttons must be applied to the BLACK and GRAY wires and must close on the BROWN wire (phase). You must use buttons with spring return ("man present" type), do not use switches with maintained position. Multiple command buttons can be connected via a parallel connection. The command buttons are subjected to the mains voltage and, therefore, must be adequately insulated and protected. If the command buttons are not used, insulate the gray and black wires.

04.4 Motor connection to home automation control units

There are different types of home automation control units. Some home automation control units allow programming the closing time of the output contacts, while others do not allow it; some home automation control units measure the current absorption of the devices applied to the output contacts, while others do not; some home automation control units work with proprietary protocols, while others work with "standard" protocols (for example KNX, MODBUS, etc...). Given the range of features of different home automation control units available on the market, the motor's Manufacturer cannot know in advance whether the motor is compatible with the home automation control unit installed. The command outputs of the home automation control unit must be connected to the push-button inputs of the motor (GRAY and BLACK wires), replacing the manual command buttons. Consequently, the home automation control unit must comply with the operating rules of the command buttons, keeping into account whether the latter function in PULSE (factory setting) or in MAN PRESENT mode (see section 12 "Button logic").

Rules for the home automation control unit to comply with to control motors with PULSE-operated buttons.

- The home automation control unit MUST NOT measure the current absorbed by the button inputs of the motor (which absorb currents lower than 1 mA).
- The home automation control unit must be connected to the motor as shown in the diagram, replacing the command buttons with the command outputs of the home automation control unit.
- To operate the motor, the home automation control unit must close the contact (up or down) for more than 0.5 seconds (typically a 1 second pulse is used).
- When the contacts are open, the home automation control unit must close a contact (up or down) for less than 0.5 seconds to stop the motor (typically a pulse of 0.2 seconds is used).

Rules for the home automation control unit to comply with to control the motors with MAN PRESENT-operated push buttons.

- The home automation control unit MUST NOT measure the current absorbed by the button inputs of the motor (which absorb currents lower than 1 mA).
- The home automation control unit must be connected to the motor as shown in the diagram, replacing the command buttons with the command outputs of the home automation control unit.
- To allow the completion of the entire opening/closing manoeuvre, the home automation control unit must be able to close the up/down contact for the time necessary for the motor to perform the complete opening/closing manoeuvre.
- To stop the motor, the home automation control unit must be able to re-open the up/down contacts at any time.

At the time of printing of this document, no particular problems concerning the connection between STAFER SPA products and home automation control units are known (if the above rules are complied with). In any case, STAFER shall not be liable in the event of lack of compatibility (even partial) with any home automation control unit. If the home automation control unit uses KNX or similar protocols, contact the home automation system supplier to discuss the rules listed above. It is likely that the home automation control unit manufacturer can provide adequate interfaces to connect the motor to the home automation control unit. For additional information, please contact your dealer.

05. SOME INFORMATION ON MOTOR OPERATION

The STAFER motor adjusts its operating principle according to the type of rolling shutter in which it is installed (blind, square bar awning or cassette awning).

Operation in BLIND mode

The motor activates the obstacle detection system during the ascent phase. If during the ascent phase an obstacle is detected in the vicinity of the lower limit switch, the ascent manoeuvre is interrupted and the motor operates in descent mode, bringing the blind back to the lower limit switch position (the motor interprets the obstacle as an anti-intrusion stop). If during the ascent phase an obstacle is detected in other positions, the ascent manoeuvre is interrupted and the motor is operated briefly in descent mode, so as to free the blind from the traction to which it is subjected because of the obstacle. If the upper limit switch has been set through contact of the blind caps with the upper stop, every 30 complete closing manoeuvres, the motor searches for the upper stop to compensate automatically for possible mechanical settling of the blind in such a way as to automatically recalibrate the limit switch.

Operation in SQUARE BARAWNING mode

The motor activates the obstacle detection system during the ascent phase, just as it does in blind mode. If the upper limit switch has been set by contact of the terminal with the square bar, every 30 complete closing manoeuvres, the motor searches for the contact of the terminal with the square bar to automatically compensate for lengthening/shortening of the shutter, always maintaining it at optimal tension.

Operation in CASSETTE AWNING mode

The motor activates the obstacle detection system during the ascent phase, just as it does in blind mode.

If the upper limit switch has been set by contact of the movable part of the cassette with the fixed part of the cassette (a typical feature in cassette awnings), at each closing of the cassette, the motor restores the limit switches so as to automatically compensate for lengthening/shortening of the shutter, always keeping it at the optimal tension and enabling correct cassette closing. In this mode, it is also possible, through the specific function (paragraph 17), to activate and adjust the time to release the shutter immediately after cassette closing.

06. MOVEMENT CONTROL FUNCTIONS

Depending on the type of installation, the motor may or may not use some electronic commands and optimises its operation based on the rolling shutter. It is however possible to operate some electronic commands by manually activating/deactivating them according to specific needs. Below is a list of available commands and how these are set by the motor at the end of the installation.

- A = function active, cannot be deactivated
- B = function active, can be deactivated
- N = function inactive, can be activated
- = function not available
- As = function active, cannot be deactivated, present only if the upper limit switch has been stored by contact with an obstacle

| Ascent obstacle detection | Stop detection | Automatic operation reset | Shutter release | Orientation |
|--|---|--|--|---|
| As soon as an obstacle is detected during the ascent phase, the motor stops and makes a brief downward movement to free the structure from traction. | As soon as a safety stop is detected during ascent, the motor stops operation and closes the rolling shutter. | If the ascent limit switch is stored by contact with an obstacle, the motor automatically recalibrates operation, as appropriate by circumstances. | Specific function for cassette awnings. When the cassette closes a brief downward movement is commanded so as to reduce the traction on the shutter. | The function allows for the stroke-operation of the rolling shutter. Function designed specifically for Adjustable Blinds (Tapparella Orientabile), but can also work on other shutter types. |
| Blinds: A Square bar awning: A Cassette awning: A | Blinds: A Square bar awning: A Cassette awning: A | Blinds: As Square bar awning: As Cassette awning: As | Blinds: - Square bar awning: - Cassette awning: N See par. 17 | Blinds: B Square bar awning: B Cassette awning: B See par. 18 |

07. INSTALLATION VIA COMMAND BUTTONS

We recommend thoroughly reading the entire procedure before performing the described operations, so as to make the procedure easier and less prone to errors.



Installation must be carried out by a qualified technician. If in doubt, contact your supplier.

A

Remove and restore power

B (1)

Bring the motor to the intermediate position

C (2)

Shortly press **3 TIMES** the button that MOVES THE MOTOR DOWNWARD

The motor signals up/down

Depending on your application, press the UP button the corresponding number of times (see below):

D (2)

With Blinds

press UP once

With Square Bar Awning

press UP twice

With Cassette Awning

press UP 3 times

E

The motor replicates the number of movements. If they do not match, repeat the operation.

F (1) Bring the blind/awning to the desired lower limit switch while pressing the DOWN button. At the end release, and briefly press UP.

WARNING! with an ORIENTA type blind, stop the motor when the blind is lowered and all the slats are completely open. To associate the fully closed blind limit switch, see paragraph 13 "THIRD LIMIT SWITCH", after "completing point I".

G

After 2 seconds the motor moves up/down

H (1) Bring the blind/awning to the desired upper limit switch while pressing the UP button. At the end, release and briefly press DOWN.

```

graph TD
    Start[Bring blind/awning to upper limit switch while pressing UP button. At the end, release and briefly press DOWN.] --> Question{Upper Stop?}
    Question -- NO --> Manual[Stop manually. Briefly press DOWN.]
    Question -- YES --> Hold[Hold down until contact, then release]
    Manual --> Wait[After the position is reached, wait 2 seconds]
    Hold --> Wait
    Wait --> Move[The motor performs a down/up movement]
    
```

After 2 seconds the motor moves up/down

I

After 2 seconds the motor moves up/down. END!

If you want to better adjust the position of the limit switches using the buttons, proceed as described in paragraphs 10 or 11. Sometimes, it is possible that, once the procedure has been completed, the motor will move opposite to the pressed button. In this case, we recommend turning the buttons or inverting the gray and black wires.

If you want to store a remote control at a later time, follow the procedure in paragraph 9.2.

Notes:

If the motor makes 4 short up/down movements, it means that it is waiting for a command. After signalling 3 times, if no commands are given, the motor will exit programming; in this case, it will be necessary to cut off power and start again from point A.

(1) the motor moves in "man present" mode: by pressing UP or DOWN, the motor moves in a certain direction until the button is released.

(2) briefly press 3 times, about 0.5 seconds between one press and the next.

08. INSTALLATION VIA REMOTE CONTROL

We recommend thoroughly reading the entire procedure before performing the described operations, so as to make the procedure easier and less prone to errors.



The product must be installed only by a qualified technician.
This motor is compatible with remote controls of the 595 and 596 series.
If in doubt, contact your supplier.

A

Remove and restore power

B (1)

Within 15 seconds, briefly press the transmitter's PROG

C (2)

Briefly press UP → Does the motor move upwards? → YES → D

NO → Press the transmitter's PROG button → C

D

Bring the motor to the intermediate position

E (3)

Press 3 times on STOP → After 2 seconds the motor moves up/down

F (3)

Depending on your application, determine how many times you wish to press the UP button:

- With Blinds x1
- With Square Bar Awning x2
- With Cassette Awning x3

The motor replicates the same number of movements. If they do not match, press the desired number again.

G

After 2 seconds the motor replicates the movements.

H (3)

If the movements match, press STOP 3 times. If they do not match, repeat point F.

I

After 2 seconds, the motor moves up and down

L Bring the blind/awning to the desired lower limit switch (2)

After you reach the desired position, press STOP 3 times (3)

WARNING! with an ORIENTA type blind, stop the motor when the blind is lowered and all the slats are completely open. To associate the fully closed blind limit switch, see paragraph 12 "THIRD LIMIT SWITCH", after completing point P.

M

After 2 seconds, the motor moves up and down

N Bring the blind/awning to the desired upper limit switch (2)

Automatic upper stop? → NO → Stop manually → After you reach the desired position, press STOP 3 times (3)

YES → Press and hold until the caps touch, then release the button

O

After 2 seconds, the motor moves down and up

P

After 2 seconds, the motor moves down and up. END!

SHOULD THE LIMIT SWITCHES BE ADJUSTED BETTER OR DO THEY NEED FINE TUNING? See paragraphs 10 and 11 (page 6).

Notes:

If the motor makes 4 short up/down movements, it means that it is waiting for a command. After signalling 3 times, if no commands are given, the motor will exit programming; in this case, it will be necessary to cut off power and start again from point A.

(1) from the moment the transmitter PROG is pressed, the push-buttons are inhibited for the entire installation procedure.

(2) the motor moves in "man present" mode: by pressing UP or DOWN on the transmitter, the motor moves in a certain direction until the button is released.

(3) briefly press 3 times, about 0.5 seconds between one press and the next.

09. ADD/DELETE A RADIO DEVICE (REMOTE CONTROL OR ANEMOMETER)

09.1 USING THE REMOTE CONTROL (Only if a remote control has already been stored)

- Bring the motor to the intermediate position.
- Briefly press PROG of a remote control already stored. Motor makes 2 upward movements.
- Within 15 seconds...
 - to add a remote control: press **STOP** or **UP** on the remote control to be added;
 - to add an anemometer: turn the impeller counterclockwise for a few seconds;
 - to delete a remote control already stored: press **DOWN** on the remote control;
 - to delete an anemometer already stored: **perform function 27** (see anemometer manual)
- 2 UP movements: device stored!!
1 DOWN movement: device deleted!!

PROG button

STOP

NOTES:

If, after pressing PROG, no signal is sent to the motor within 15 seconds, the motor will exit the menu without signalling anything.

The only stored remote control can also be deleted. To associate another one at a later time, it is necessary to proceed with the buttons (paragraph 09.2)

09.2 USING THE COMMAND BUTTONS (If there is no functioning device stored)

- Bring the motor to the intermediate position.
- Turn off the power, wait a few seconds, then power up again.
- Within 15 seconds, briefly and quickly press **UP 3 times** and **DOWN 3 times**. The motor moves up/down.
- Within 15 seconds, briefly and quickly press **UP once** and **DOWN once**. After 10 seconds motor makes 2 upward movements.
- Within 15 seconds...
 - to add a remote control: press **STOP** or **UP** on the remote control to be added;
 - to add an anemometer: turn the impeller counterclockwise for a few seconds;
- The motor performs 2 movements up: device stored!!

3 x UP
3 x DOWN

1 x UP
1 x DOWN

STOP

NOTES:

If, after pressing UP 3 times and DOWN 3 times, no signal is sent to the motor within 15 seconds, the motor leaves the menu without signalling anything.

10. FINE-TUNING OF UPPER LIMIT SWITCH

WARNING:

Fine-tuning of the upper limit switch is not possible if the limit switch has been set by contact with a stop plate.

10.1 USING THE REMOTE CONTROL

01. Bring the motor to the intermediate position.
02. Press **MENU** with 596. Display shows: -- / With 595 press quickly 3 times on **PROG*** (red led on). Motor moves up/down.
03. Press **DOWN** once. The 596 display shows 01.
04. Press **STOP**. The motor performs a brief up/down movement.
05. Press **UP**. The motor moves to the upper limit switch. Wait until it stops.
06. Adjust the new position with **UP / DOWN**.
07. Once you have found the position, press **PROG**. After 10 sec. the motor performs a brief DOWN/UP movement.
08. Press **MENU** with 596 to exit. / Press quickly 3 times on **PROG*** with 595 (red led off).

MENU

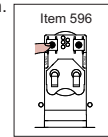

3 x PROG

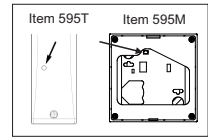

10.2 USING COMMAND BUTTONS

01. Bring the motor to the intermediate position.
02. Turn off the power, wait a few seconds, then power up again.
03. Within 15 seconds, briefly and quickly press **UP 3 times** and **DOWN 3 times**. The motor completes 1 UP/DOWN movement.
04. Within 15 seconds, briefly press **DOWN once**. After 10 seconds motor moves.
05. Press **UP once**. The motor moves to the upper limit switch. Wait until it stops.
06. Adjust the new position with **UP / DOWN**.
07. Once positioned, wait 5 seconds.
The motor completes 1 down/up movement. Limit switch setting stored!!

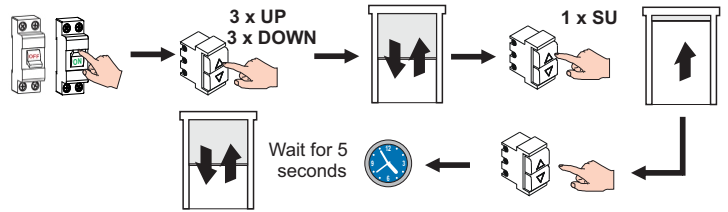

(*) The buttons must be pressed shortly, max 0,5 seconds between two pressures.

11. FINE-TUNING OF LOWER LIMIT SWITCH

11.1 USING THE REMOTE CONTROL

01. Bring the motor to the intermediate position.
02. Press **MENU** with 596. The display shows -- / With 595 press quickly 3 times on **PROG*** (red led on). Motor moves up/down.
03. Press **DOWN** once. The 596 display shows 01.
04. Press **STOP**. The motor performs a brief up/down movement.
05. Press **DOWN**. The motor moves to the lower limit switch. Wait until it stops.
06. Adjust the new position with **UP / DOWN**.
07. Once you have found the position, press **PROG**. After 10 sec. the motor performs an UP/DOWN movement.
08. With the 596, press **MENU**. / With the 595, press quickly **PROG*** 3 times to exit (red led off).

MENU

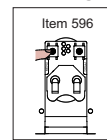

3 x PROG

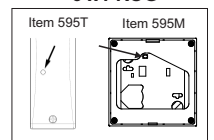

11.2 USING COMMAND BUTTONS

01. Bring the motor to the intermediate position.
02. Turn off the power, wait a few seconds, then power up again.
03. Within 15 seconds, briefly and quickly press **UP 3 times** and **DOWN 3 times**. The motor completes 1 UP/DOWN movement.
04. Within 15 seconds, briefly press **DOWN once**. After 10 seconds motor moves.
05. Press **DOWN once**. The motor moves to the lower limit switch. Wait until it stops.
06. Adjust the new position with **UP / DOWN**.
07. Once positioned, wait 5 seconds.
The motor completes 1 down/up movement. Limit switch setting stored!!

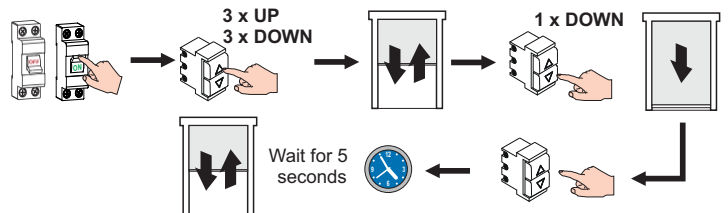

(*) The buttons must be pressed shortly, max 0,5 seconds between two pressures.

12. BUTTON LOGIC

The command buttons can work in PULSE logic or in MAN PRESENT logic.

PULSE: to move the motor, press a button for at least 0.5 seconds, to stop the motor, briefly press (less than 0.5 seconds) one of the two buttons.

MAN PRESENT: to move the motor, press a button for at least 0.5 seconds, release the button to stop the motor.

The factory sets the motor to work in PULSE logic. To modify this parameter, follow the instructions provided below.

12.1 USING THE REMOTE CONTROL Item 596

01. Bring the motor to the intermediate position.
02. Press **MENU**. The motor performs an up/down movement. Display shows: -- .
03. Press **4 times on DOWN**. 04 appears on the display.
04. Press **STOP**. The motor shows:
1 UP = man present, 1 DOWN = pulse.
05. To select "Pulse": press **DOWN**
To select "man present": press **UP**
06. After pressing, the motor shows:
1 UP = man present, 1 DOWN = pulse.
07. Press **MENU** to exit.

12.2 USING REMOTE CONTROL Item 595

01. Bring the motor to the intermediate position.
02. Press quickly **3 times on PROG*** (red led on). Motor moves up/down.
03. Press **4 times on DOWN**.
04. Press **STOP**. The motor shows:
1 UP = man present, 1 DOWN = pulse. Advanced Info
05. To select "Pulse": press **DOWN**.
To select "man present": press **UP**.
06. After pressing, the motor shows:
1 UP = man present, 1 DOWN = pulse.
07. Press quickly **PROG 3 times** to exit (red led off).

12.3 USING COMMAND BUTTONS

01. Bring the motor to the intermediate position.
02. Turn off the power, wait a few seconds, then power up again.
03. Within 15 seconds, briefly and quickly press **UP 3 times** and **DOWN 3 times***. The motor performs an up/down movement.
04. Within 15 seconds, briefly and quickly press **DOWN 4 times**.
After 10 seconds the motor shows: 1 UP = man present, 1 DOWN = pulse.
05. To select "Pulse": briefly press **DOWN**.
To select "Man present": briefly press **UP**.
06. The motor shows: 1 UP = man present, 1 DOWN = pulse.
07. Wait for 5 seconds. The motor exits the menu without any movement.

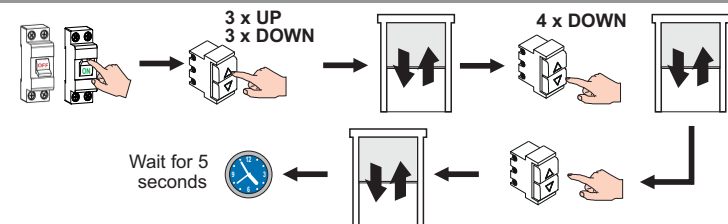

(*) The buttons must be pressed shortly, max 0,5 second between two pressures.

13. THIRD LIMIT SWITCH (PREFERRED POSITION)

In the case of blinds with ADJUSTABLE slats, it is possible to decide whether to associate the THIRD LIMIT SWITCH to the fully lowered blind position with open slats or to the lowered blind position with closed slats. In any case, it is better to initially associate the THIRD LIMIT SWITCH to the completely lowered position with slats closed, since the LOWER limit switch has already been stored and associated with the completely lowered blind position with open slats. Subsequently, it is possible to invert the LOWER LIMIT SWITCH with the THIRD LIMIT SWITCH at will and at any time (see paragraph 14).

13.1 USING REMOTE CONTROL Item 596

To store the THIRD LIMIT SWITCH:

01. Bring the motor to the intermediate position.
02. Briefly press **MENU** on the back. The motor performs an up/down Display shows: --. Press **DOWN** twice. 02 appears on the display.
04. Press **STOP**. The motor moves to the lower limit switch.
04. Move the motor to the desired position (with ADJUSTABLE slats, close blind and slats completely).
05. Press **PROG** to store settings. The motor performs an up/down movement.
06. Press **MENU** to exit.

To call up:

01. Press the THIRD LIMIT SWITCH button on the remote control.

13.2 USING REMOTE CONTROL Item 595

To store the THIRD LIMIT SWITCH:

01. Bring the motor to the intermediate position.
02. Press quickly **3 times on PROG*** on the back (red led on). The motor performs an up/down movement.
03. Press **DOWN twice**. The motor performs an up/down movement.
04. Press **STOP**. The motor moves to the lower limit switch.
05. Move the motor to the desired position (with ADJUSTABLE slats, close blind and slats completely).
06. Press **PROG** to store settings. After 5 sec. the motor performs up/down.
07. Press quickly **3 times on PROG*** to exit (red led off).

To call up:

01. Briefly press STOP 3 times.

13.3 USING COMMAND BUTTONS

To store:

01. Bring the motor to the intermediate position.
02. Turn off the power, wait a few seconds, then power up again.
03. Within 15 seconds, briefly and quickly press **UP 3 times** and **DOWN 3 times***. The motor completes 1 up/down movement.
04. Within 15 seconds, briefly and quickly press **DOWN twice**. After 10 seconds the motor moves to the lower limit switch.
05. Press the buttons bringing the motor to the desired position.
06. After 5 seconds the motor performs an up/down movement.

To call up:

01. Quickly press DOWN 3 times.

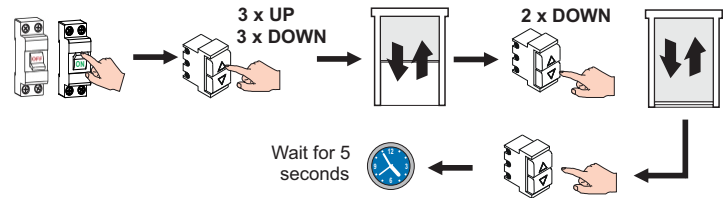

(*) The buttons must be pressed shortly, max 0,5 seconds between two pressures.

14. THIRD LIMIT SWITCH INVERSION

In the case of blinds with ADJUSTABLE slats, it is possible to decide whether to associate the THIRD LIMIT SWITCH to the fully lowered blind position with open slats or to the lowered blind position with closed slats. In any case, it is better to initially associate the THIRD LIMIT SWITCH to the completely lowered position with slats closed, since the LOWER limit switch has already been stored and associated with the completely lowered blind position with open slats.

If you try to invert the THIRD LIMIT SWITCH before storing its settings, an error is signalled by 4 movements of the motor. It is possible to invert the LOWER LIMIT SWITCH with the THIRD LIMIT SWITCH at any time, proceeding as follows:

14.1 USING REMOTE CONTROL Item 596

01. Bring the motor to the intermediate position
02. Briefly press **MENU** on the back. The motor performs an up/down movement. Display shows: --. Press **3 times on DOWN**. 03 appears on the display.
03. Press **STOP**. The motor moves to the lower limit switch position.
04. Press **UP** once. The lower limit switch has been reversed with the third limit switch.
05. The motor signals **UP**.
06. Press **MENU** to exit.

14.2 USING REMOTE CONTROL Item 595

01. Bring the motor to the intermediate position
02. Press quickly **3 times on PROG*** on the back (red led on). Motor moves up/down.
03. Press **DOWN 3 times**.
04. Press **STOP**. The motor moves to the lower limit switch position.
05. Press **UP** once.
06. After 5 sec. the motor signals **UP**. The limit switch has been reversed.
07. Press quickly **3 times on PROG*** to exit (red led off).

14.3 USING COMMAND BUTTONS

01. Bring the motor to the intermediate position.
02. Turn off the power, wait a few seconds, then power up again.
03. Within 15 seconds, briefly and quickly press **UP 3 times** and **DOWN 3 times***. The motor moves up/down.
04. Within 15 seconds, briefly and quickly press **DOWN 3 times**. After 10 seconds the motor moves to the lower limit switch position.
05. Briefly press **UP** to invert the third limit switch.
06. After 5 seconds the motor signals **UP**.
07. Wait for 5 seconds. The motor exits the menu without any movement.

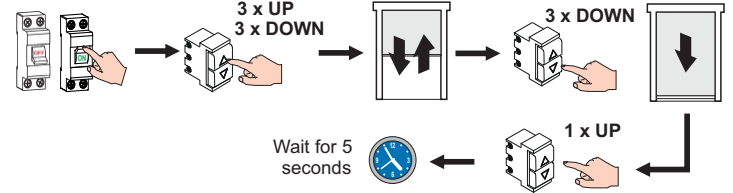

(*) The buttons must be pressed shortly, max 0,5 seconds between two pressures.

15. SUN AND WIND ANEMOMETERS

The sun/wind sensors generate automatic operations without warning, which can be a source of danger. The installer is responsible for informing the end user and possibly integrating appropriate safety systems to the installation. In some situations, (e.g., loss of motor or sensor voltage, motor or sensor failure, radio disturbances, etc.), it is possible that the command given by the sensor may not be detected by the motor. The sensor must therefore not be understood as a safety device designed to guarantee the integrity of the rolling shutter under all conditions, but a means to reduce the probability that the rolling shutter will be damaged by adverse weather events.

15.1 ANEMOMETERS COMPATIBLE WITH RX-E3 MOTORS

The V6.RX-E3 and V7.RX-E3 motors feature an integrated radio receiver and require the use of radio anemometers. Use model 595.K.XS.00 (sun/wind sensor for one or more motors). The sensor constantly communicates to the associated motors wind intensity and brightness. Each motor, depending on the thresholds set inside it, decides whether to trigger the wind or the sun alarm. In the event of wind alarm, the motor engages the upward mode, also inhibiting the manual commands until the end of the alarm. In the event of sun alarm, the tuned motors activate a descent mode. When the sensor detects the absence of sun, the message "no sun" is sent to the motors. In turn, the motors activate the ascent mode. For more information, refer to the relevant anemometer manual.

Sun function activation with remote control Item 596

Select the channel associated with the motor (except "SE" Sequencer)

Press the SUN button on the remote control until the state of the YELLOW LED varies (about 2 seconds). The motor moves up/down to confirm the change.

YELLOW LED LIGHT ON/OFF:
"sun" function active/off

For clarification, refer to the manual of your sun-wind sensor.

Sun function activation with remote control Item 595

01. Bring the motor to the intermediate position.
02. Press quickly **3 times on PROG** on the back (red led on). The motor shows: up/down.
03. Press **UP twice** and **DOWN twice**, then press **STOP**.
04. The motor shows: up/down.
05. To activate, press **UP once**. To deactivate, press **DOWN once**.
06. After 2 seconds, the motor replicates the movement.
07. Press quickly **3 times on PROG*** to exit (the motor does not show anything, red led off).

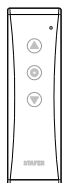

For clarification, refer to the manual of your sun-wind sensor.

16. SUN/WIND ANEMOMETER RADIO TEST

As soon as a sun/wind radio anemometer is stored in the motor, a communication check is automatically activated between radio anemometer and motor. Communication between the two devices occurs every 15 seconds. If communication fails twice consecutively, the motor performs an ascent manoeuvre to protect the rolling shutter. The automatic protection manoeuvre is performed only once, remaining in place until radio communication is restored. It is possible to "query" the motor on the alarm status. Please refer to the anemometer manual.

17. SHUTTER RELEASE (FOR CASSETTE AWNINGS ONLY)

This is a specific function available only in the CASSETTE AWNING installation mode. The factory sets this function as "inactive". If the function is activated, when the cassette closes a very brief downward movement is commanded so as to reduce the traction on the shutter with closed cassette. The duration of the movement can be set (see Table 01 - Shutter Release) following the procedure below.

| No. of movements | Threshold |
|------------------|---------------------|
| 1 | Function not active |
| 2 | 10 msec |
| 3 | 20 msec |
| 4 | 30 msec |
| 5 | 40 msec |

Tab. 01 - Shutter Release

17.1 USING REMOTE CONTROL Item 596

01. Bring the motor to the intermediate position.
02. Briefly press **MENU** on the back. The motor performs an up/down movement.
03. Display shows: - - -. Press **DOWN 6 times**. 06 appears on the display.
04. Press **STOP**. The motor performs an up/down movement.
05. Press **UP**. The motor shows the current value (from 1 to 5 movements).
06. Press **UP** as many times as the setting you want (from 1 to 5).
07. Press **STOP**. The motor shows the new setting (from 1 to 5 movements).
08. Press **MENU** to exit.

17.2 USING REMOTE CONTROL Item 595

01. Bring the motor to the intermediate position.
02. Press quickly **3 times on PROG*** (red led on). Motor moves up/down.
03. Press **6 times on DOWN**.
04. Press **STOP**. The motor shows the current value (from 1 to 5 movements).
05. Press **UP** as many times as the setting you want (from 1 to 5).
06. Press **STOP**. The motor shows the new setting (from 1 to 5 movements).
07. Press quickly **3 times on PROG*** to exit (red led off).

17.3 USING COMMAND BUTTONS

01. Bring the motor to the intermediate position.
02. Turn off the power, wait a few seconds, then power up again.
03. Within 15 seconds, briefly and quickly press **UP 3 times** and **DOWN 3 times***. The motor performs an up/down movement.
04. Within 15 seconds, briefly and quickly press **DOWN 6 times**. After 10 seconds the motor performs an up/down movement.
05. Press **UP**. The motor signals the current value (from 1 to 5 movements).
06. Briefly press **UP** the number of times equal to the desired setting (from 1 to 5). After 2 seconds, the motor signals the new setting (from 1 to 5 movements).
07. Wait for 5 seconds. The motor exits the menu without any movement.

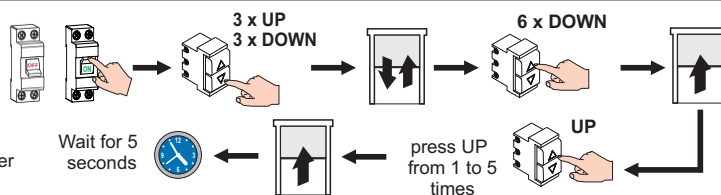

(*) The buttons must be pressed shortly, max 0,5 seconds between two pressures.

18. ORIENTATION (MICRO MOVEMENTS)

Allows you moving the motor in short strokes. Useful function for situations in which the rolling shutter consists of adjustable slats. The function is already active, but can be deactivated and customised.

If the function is active, you can use both the wall-mounted buttons and the remote control to move the motor in strokes:

- with the wall-mounted buttons (only with pulse logic), briefly press a button, then immediately press the same button again, keeping it pressed.
- with remote control Item 596, keep pressed the two special buttons with curved arrows (if necessary, refer to the manual of the remote control supplied).
- with remote control Item 595, briefly press **STOP** twice, then immediately afterwards hold down the **UP** or **DOWN** button (if necessary, refer to the manual of the remote control supplied).

| No. of movements | Threshold |
|------------------|---------------------|
| 1 | Function not active |
| 2 | 50 msec |
| 3 | 100 msec |
| 4 | 150 msec |
| 5 | 200 msec |

Tab. 02 - Orientation Time

It is possible to adjust the duration of the strokes (see Table 02 - Orientation Time). To modify this parameter, follow the instructions provided below.

18.1 USING REMOTE CONTROL Item 596

01. Bring the motor to the intermediate position.
02. Briefly press **MENU**. The motor moves up/down. Display shows: - - .
03. Within 15 seconds, briefly and quickly press **UP 3 times** and **DOWN 3 times***. The motor moves up/down.
04. Press **STOP**. The motor shows: up/down.
05. Press **UP**. The motor shows the current value (from 1 to 5 movements).
06. Press the **UP** button a number of times equal to the desired setting (from 1 to 5).
07. After 5 seconds, the motor signals the new setting (from 1 to 5 movements).
08. Press **MENU** to exit

To adjust:

01. Press the **ORIENTATION** button on the remote control.

18.2 USING REMOTE CONTROL Item 595

01. Bring the motor to the intermediate position.
02. Press quickly **3 times on PROG*** (red led on). The motor shows: up/down.
03. Press **7 times on DOWN**.
04. Press **STOP**. The motor shows: up/down.
05. Press **UP**. The motor shows the current value (from 1 to 5 movements).
06. Press **UP** as many times as the setting you want (from 1 to 5).
07. After 5 seconds, the motor signals the new setting (from 1 to 5 movements).
08. Press quickly **3 times on PROG*** to exit (red led off).

To adjust:

01. Briefly press **twice on STOP**, and then hold down **UP** or **DOWN**.

18.3 USING COMMAND BUTTONS

01. Bring the motor to the intermediate position.
02. Turn off the power, wait a few seconds, then power up again.
03. Within 15 seconds, briefly and quickly press **UP 3 times** and **DOWN 3 times***. The motor moves up/down.
04. Within 15 seconds, briefly and quickly press **DOWN 7 times**. After 10 seconds the motor shows: up/down.
05. Press **UP**. The motor shows the current value (from 1 to 5 movements).
06. Briefly press **UP** as many times as the setting you want (from 1 to 5).
07. After 5 seconds, the motor signals the new setting (from 1 to 5 movements).
08. Wait for 5 seconds. The motor exits the menu without any movement.

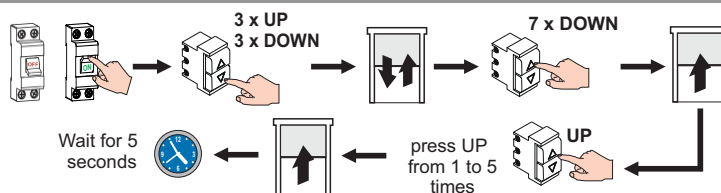

(*) The buttons must be pressed shortly, max 0,5 seconds between two pressures.

19. FACTORY VALUE RESET

19.1 USING REMOTE CONTROL Item 596

01. Bring the motor to the intermediate position.
02. Press **MENU**. The motor moves up/down. Display shows: - - .
03. Press **UP twice** and **DOWN 9 times**, 29 appears on the display.
04. Press **STOP**, the motor makes 6 movements up and down. Wait until it stops.
05. Press **UP twice** until the motor signals that the reset has been completed (1 double movement).
06. Press **MENU** to exit.
07. Install the motor again (see section 6 or 7 of this manual).

(*) The buttons must be pressed shortly, max 0,5 seconds between two pressures.

19.3 USING THE WALL-MOUNTED BUTTON (IF ANY)

01. Bring the motor to the intermediate position.
02. Turn off the power, wait a few seconds, then power up again.
03. Within 15 seconds, briefly and quickly press **UP 3 times** and **DOWN 3 times**. The motor moves up/down.
04. Within 15 seconds, briefly and quickly press **UP twice** and **DOWN 9 times**. After 5 seconds the motor performs 6 up/down movements.
05. At the end of the movements, briefly press **UP twice**.
06. The motor signals that the reset has been carried out (1 double movement).

19.4 USING THE POWER CABLES

01. If possible, bring motor to an intermediate position.
02. Cut off the power supply.
03. Connect as shown in the diagram on the side.
04. Power up the motor. The motor signals 6 up/down movements.
06. Cut off the power supply.
07. Restore the connections. (REFER to diagram in paragraph 4)
08. Install the motor again (see paragraph 5 or 6 of this manual).

19.2 USING REMOTE CONTROL Item 595

01. Bring the motor to the intermediate position.
02. Press quickly **3 times on PROG***. The motor shows: up/down.
03. Press **twice on UP** and **9 times on DOWN**.
04. Press **STOP**, the motor makes 6 movements up and down. Wait until it stops.
05. Press **UP twice** until the motor signals that the reset has been completed (1 double movement).
06. Press quickly **3 times on PROG*** to exit.
07. Install the motor again (see section 6 or 7 of this manual).

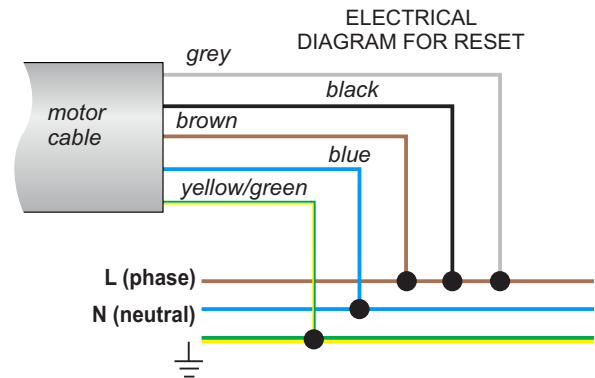

SIMPLIFIED DECLARATION OF CONFORMITY

The manufacturer STAFER S.p.a. declares that the product complies with Directives 2014/53/EU, 2014/35/EU, and 2014/30/EU.



All rights reserved.
STAFER S.p.a. - via Malpighi, 9 - 48018 Faenza (RA) ITALY
Tel. (+39) 0546.624811 - Fax (+39) 0546.623141 - www.stafer.com



All products and technical specifications given in this document are subject to variation without prior notice.
Unless previously and specifically authorised by STAFER, the device must be used exclusively with transmitters produced by STAFER.
STAFER cannot be considered responsible for damage caused by improper, incorrect or unreasonable uses.